

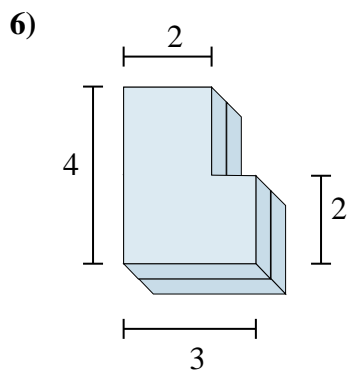

Encontrar el valor total de cada figura mostrada.

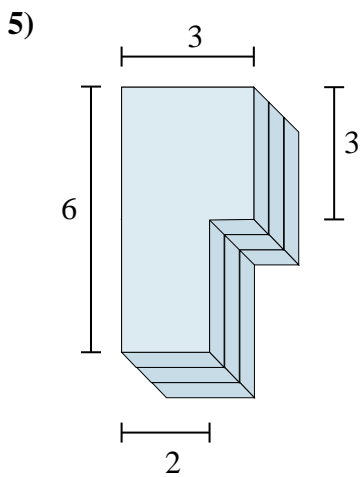
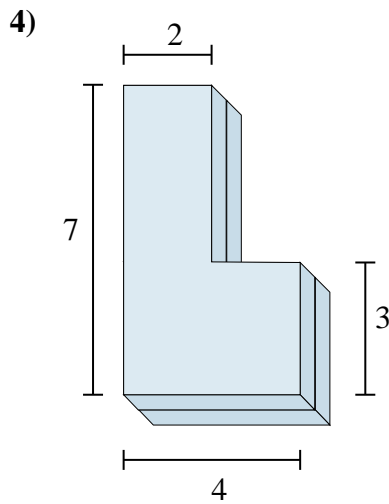
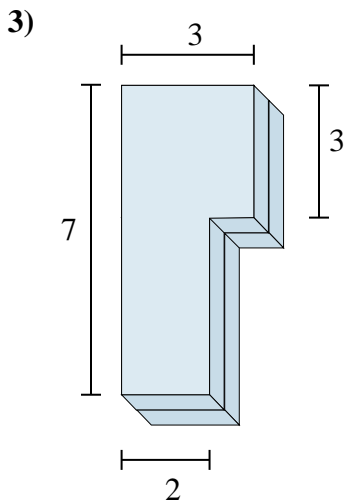
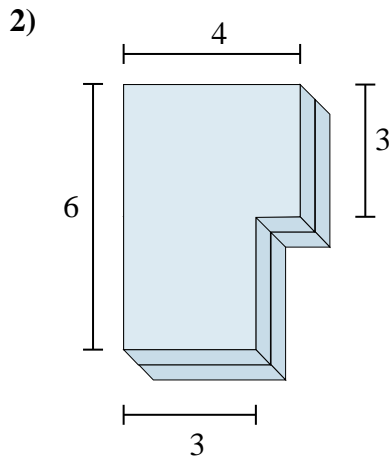
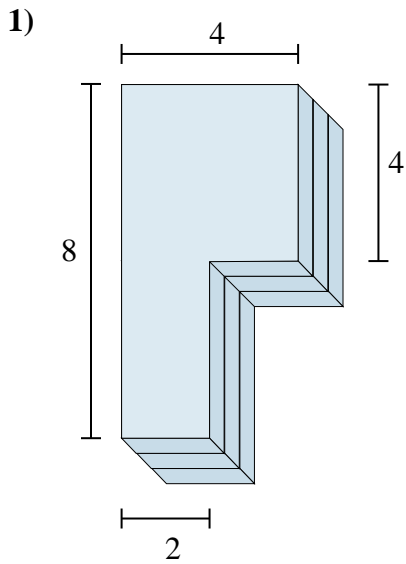

Respuestas

- 1. _____
- 2. _____
- 3. _____
- 4. _____
- 5. _____
- 6. _____



Encontrar el valor total de cada figura mostrada.

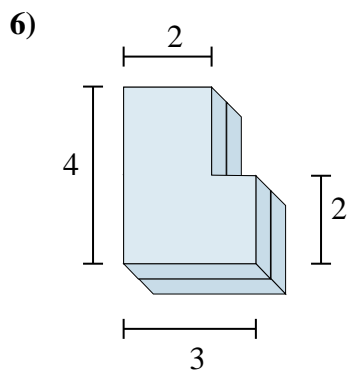
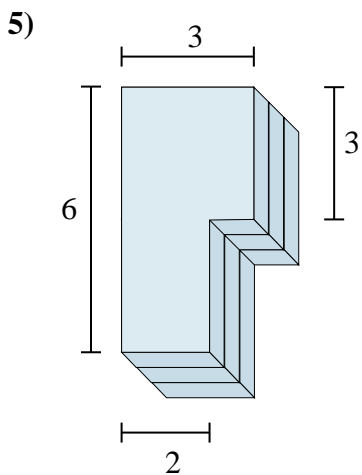
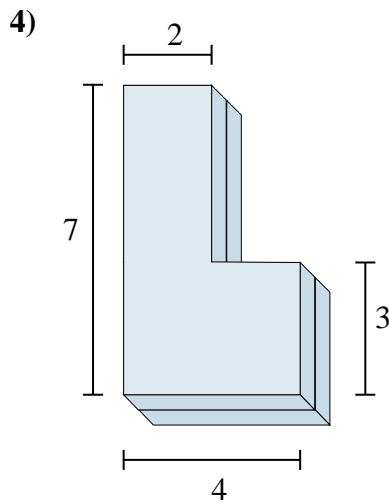
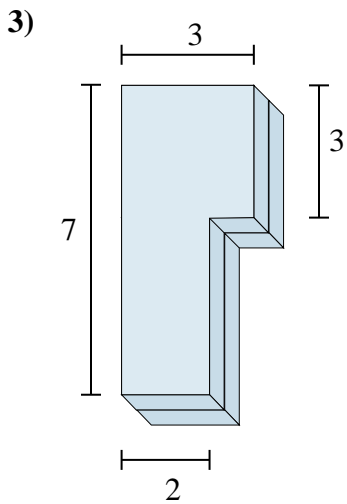
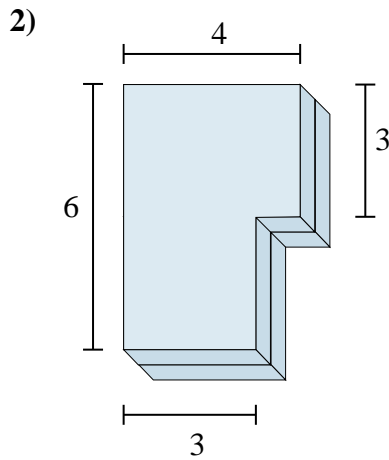
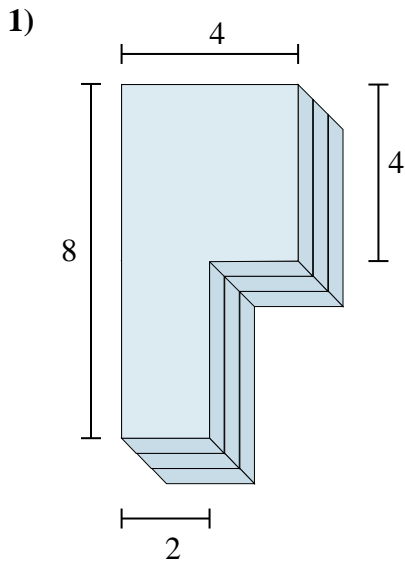

Respuestas

1. **72 cm³**

2. **42 cm³**

3. **34 cm³**

4. **40 cm³**

5. **45 cm³**

6. **20 cm³**



Encontrar el valor total de cada figura mostrada.

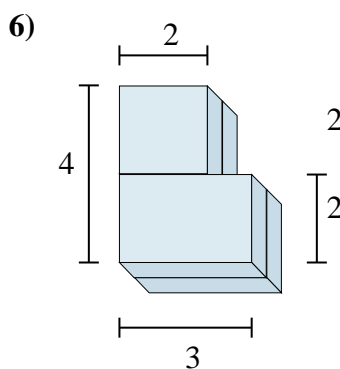
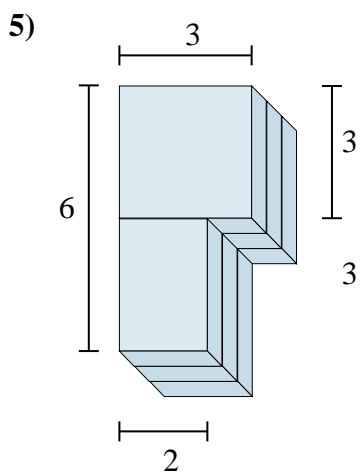
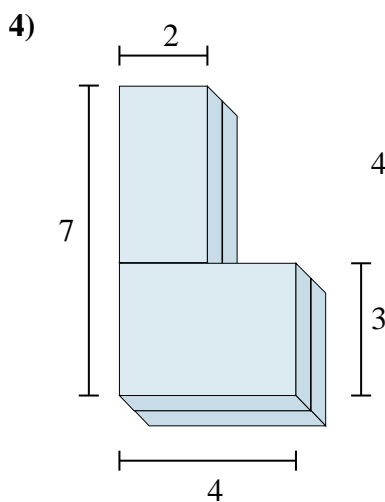
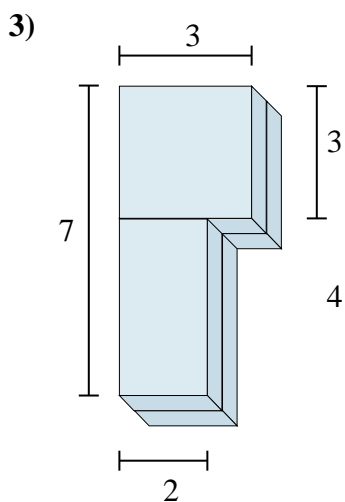
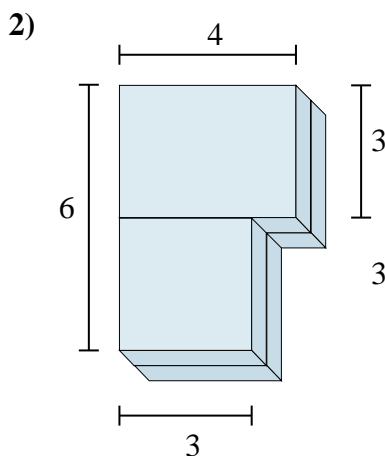
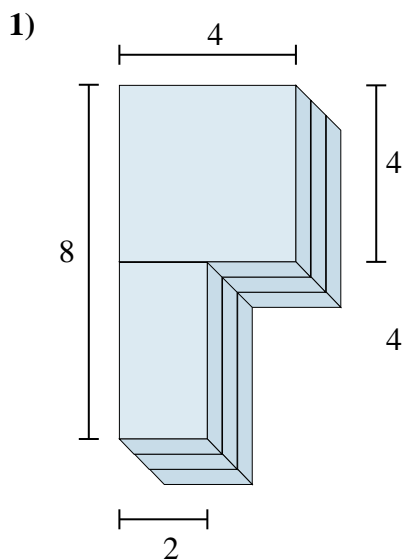

Respuestas

1. _____
2. _____
3. _____
4. _____
5. _____
6. _____