

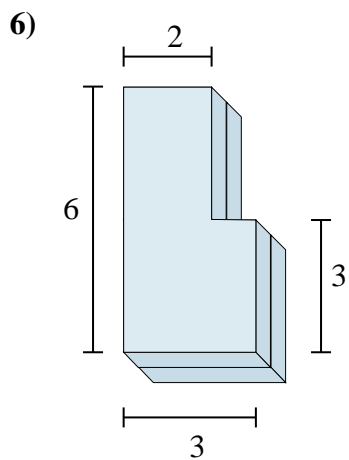

Encontrar el valor total de cada figura mostrada.

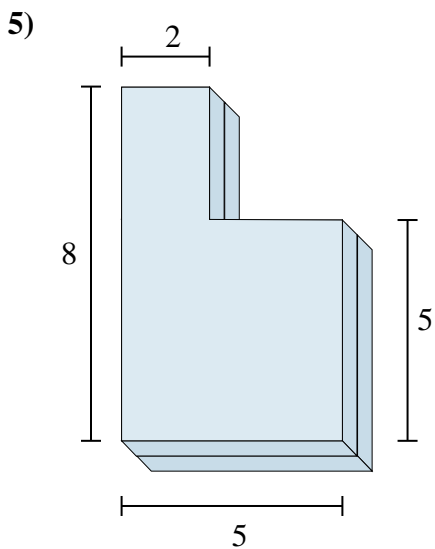
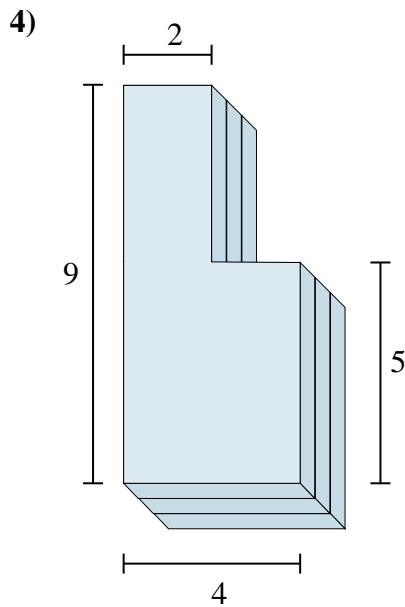
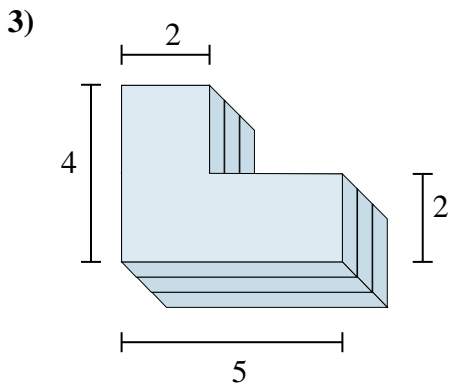
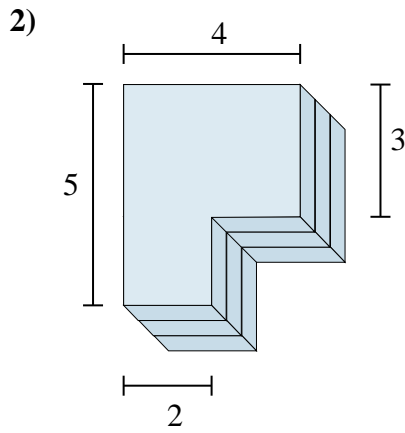
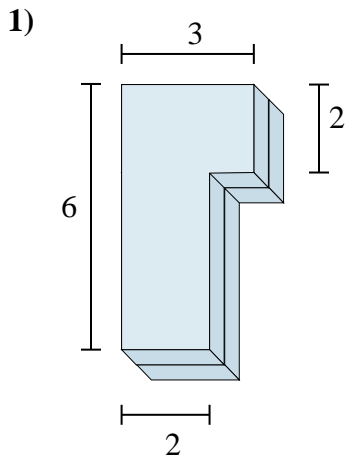

Respuestas

1. _____

2. _____

3. _____

4. _____

5. _____

6. _____



Encontrar el valor total de cada figura mostrada.

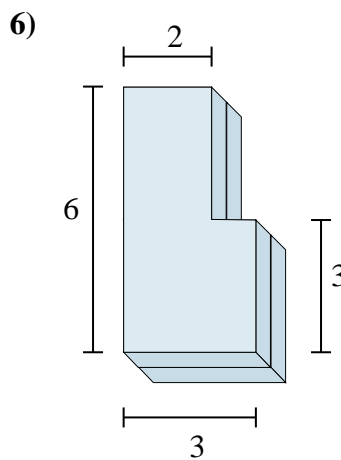
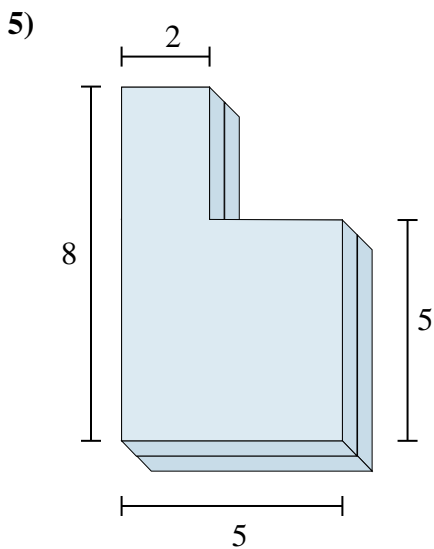
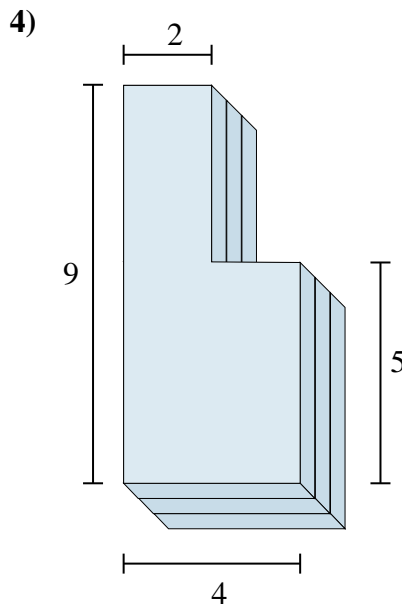
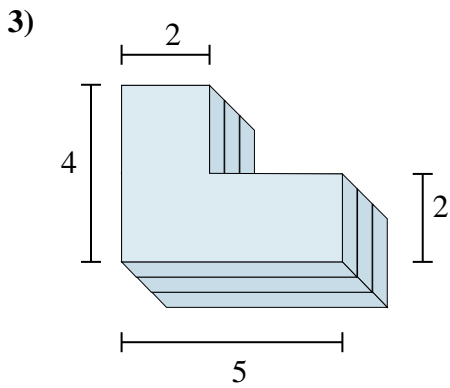
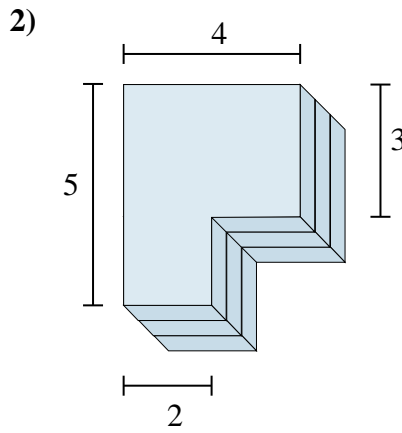
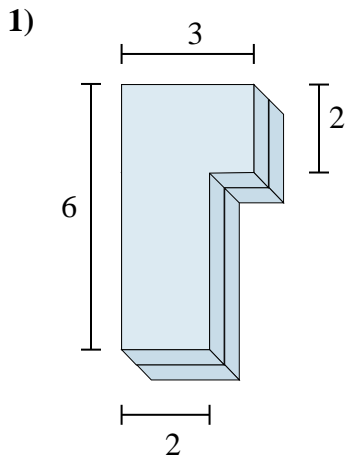

Respuestas

1. 28 cm³
2. 48 cm³
3. 42 cm³
4. 84 cm³
5. 62 cm³
6. 30 cm³



Encontrar el valor total de cada figura mostrada.

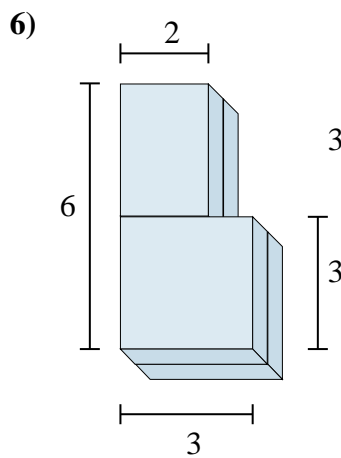
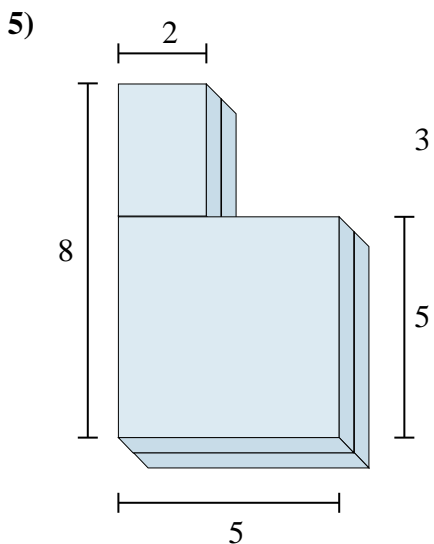
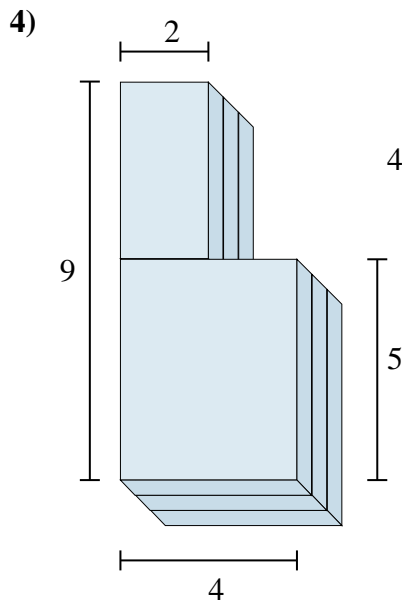
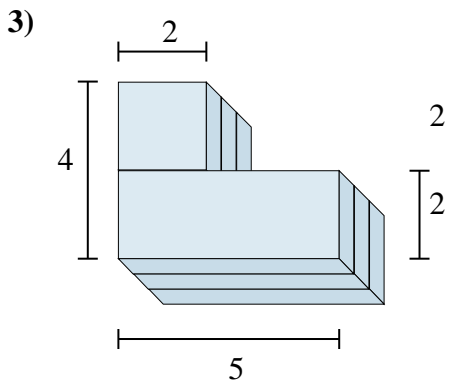
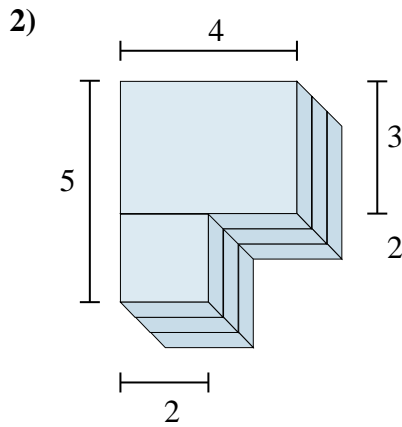
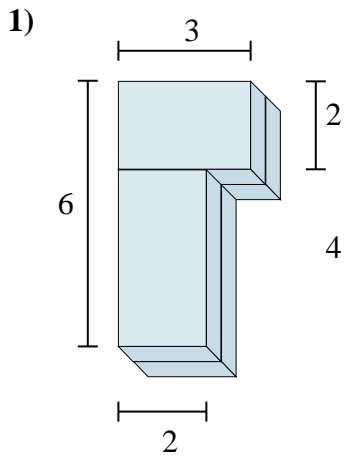

Respuestas

1. _____
2. _____
3. _____
4. _____
5. _____
6. _____