

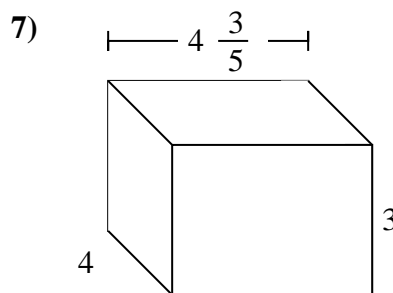

Rellenar cada prisma rectangular con cubos para determinar el volumen. Cada unidad de prisma es medida en cm (no a escala).

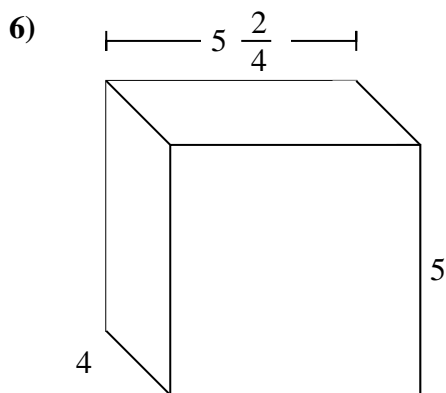
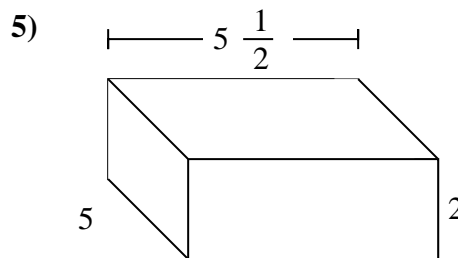
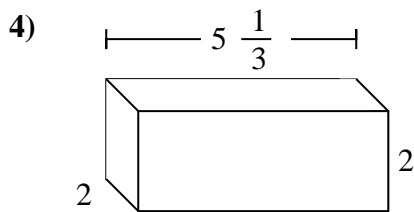
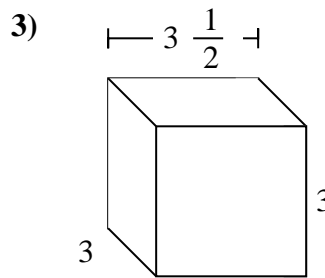
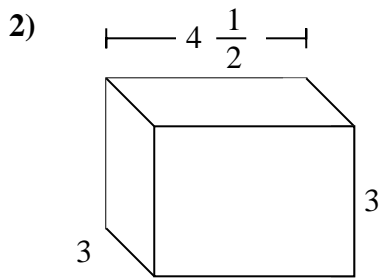
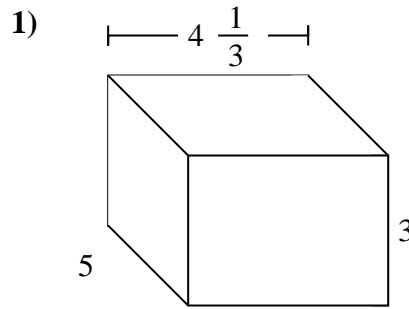
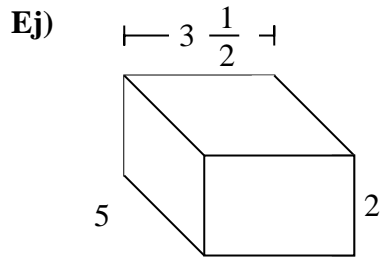

Respuestas

Ej. **35 cm**

1. _____

2. _____

3. _____

4. _____

5. _____

6. _____

7. _____



Rellenar cada prisma rectangular con cubos para determinar el volumen. Cada unidad de prisma es medida en cm (no a escala).

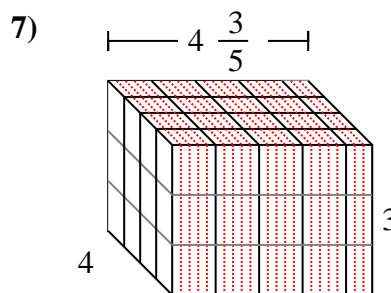
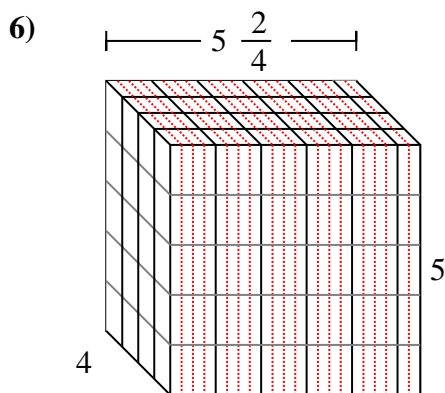
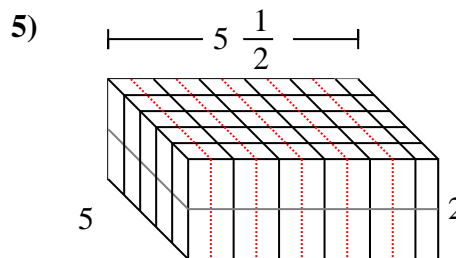
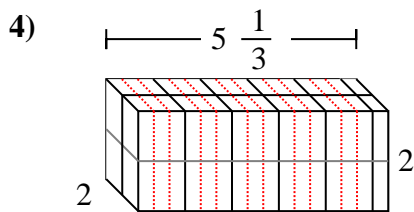
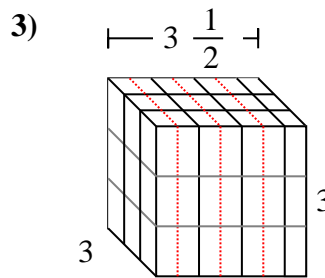
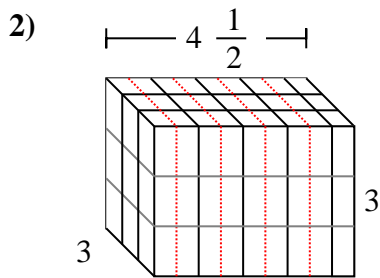
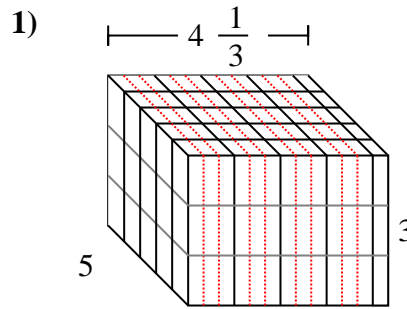
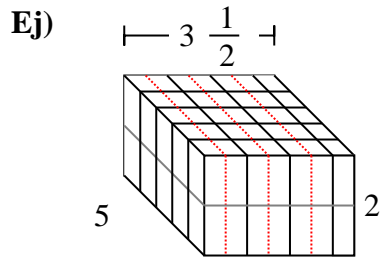

Respuestas

Ej. 35 cm

1. 65 cm

2. $40 \frac{1}{2}$ cm

3. $31 \frac{1}{2}$ cm

4. $21 \frac{1}{3}$ cm

5. 55 cm

6. 110 cm

7. $55 \frac{1}{5}$ cm